

MODÈLE/MODEL
0-802

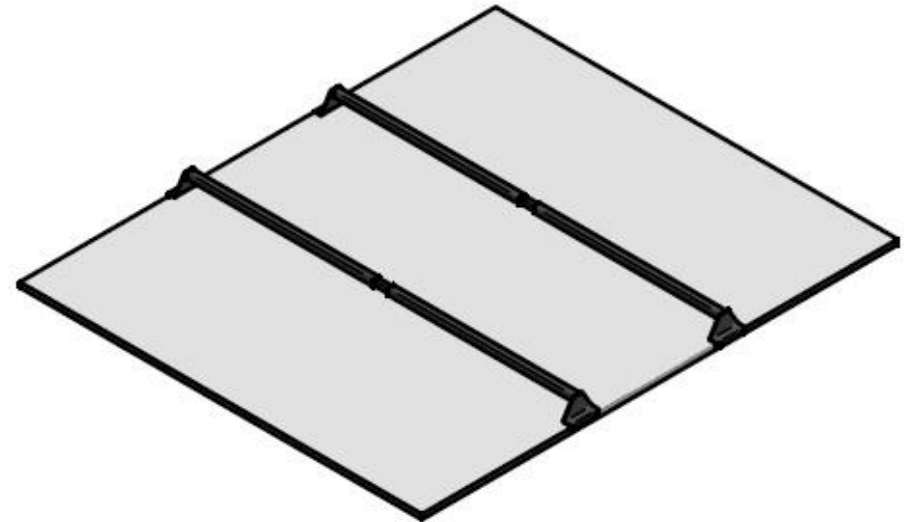

ARVIKA.ca

1-888-690-0096
1125 ROUTE ÉDOUARD VII, SAINT-PHILIPPE

**EXTREMEMENT IMPORTANT /
EXTREMELY IMPORTANT**

Appliquer du calfeutrage sur toutes les ouvertures des barres et du toit pour empêcher l'infiltration d'eau.

Seal all openings of the bars and the roof with caulking to prevent water infiltration

TOOLS NEEDED: SQUARE BIT
SCREWDRIVER AND ALLEN KEY 1/8

OUTILS REQUIS: TOURNEVIS À TÊTE
CARRÉE ET CLÉ ALLEN 1/8

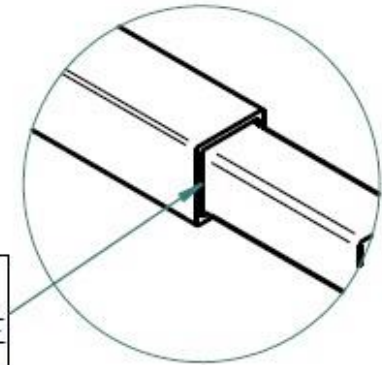

SCELLEZ ICI
APPLY SEAL HERE

DETAIL C

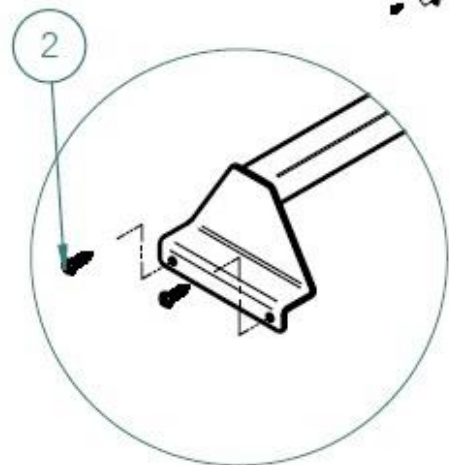
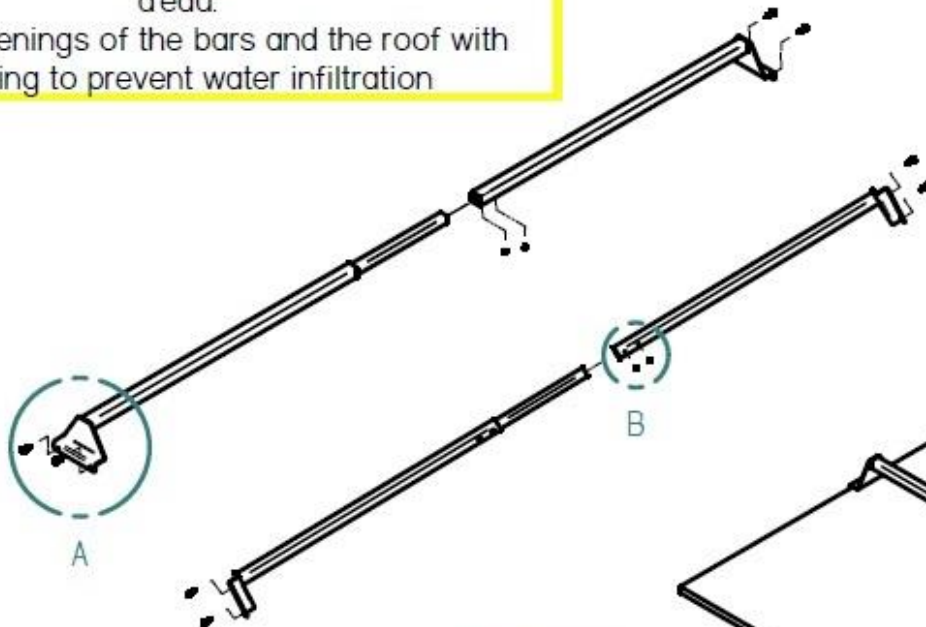

DETAIL A

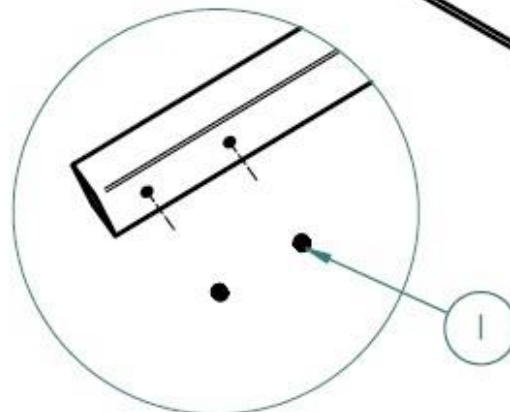

DETAIL B

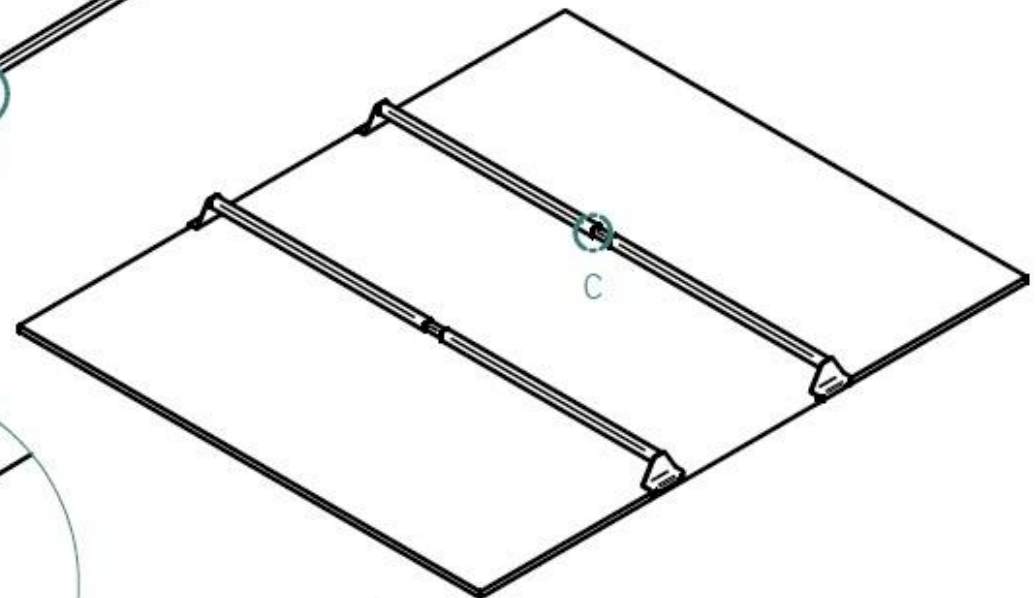

ARVIKA MARKETING		
PART LIST: 802		
REP.	QTÉ.	PART NUMBER
1	4	VIS/ALLEN SCREW 1/8 X 1/4-20
2	8	VIS METAL/TAP SCREW 1/4 X 1